

Transient Voltage Suppressors Array for ESD Protection

Low Capacitance

SLVU2.8

Description

The SLVU2.8 is designed to protect voltage sensitive components from ESD and transient voltage events. Excellent clamping capability, low leakage, and fast response time, make these parts ideal for ESD protection on designs where board space is at a premium.

Feature

- u 400 Watts Peak Pulse Power per Line (tp=8/20µs)
- u Protects two line pairs (four lines)
- u Low capacitance
- u RoHS Compliant
- u IEC61000-4-2 (ESD) ±15kV (air), ±8kV (contact)
- u IEC61000-4-4 (EFT) 40A (5/50ns)
- u IEC61000-4-5 (Lightning) 24A (8/20µs)

Applications

- u 10/100 Ethernet
- u WAN/LAN Equipment
- u Laser Diode Protection
- u Switching Systems
- u Instrumentation
- u Base Stations

SOT-23

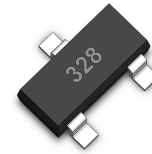

Functional Diagram

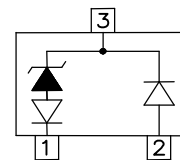

Mechanical Data

- u JEDEC SOT-23 Package
- u Molding Compound Flammability Rating : UL 94V-0
- u Weight 8.0 Milligrams (Approximate)
- u Quantity Per Reel : 3,000pcs
- u Reel Size : 7 inch
- u Lead Finish : Lead Free

Mechanical Characteristics

Symbol	Parameter	Value	Units
P _{PP}	Peak Pulse Power (tp=8/20µs waveform)	400	W
T _L	Lead Soldering Temperature	260 (10sec)	°C
T _{STG}	Storage Temperature Range	-55 to +150	°C
T _J	Operating Temperature Range	-55 to +150	°C
	IEC61000-4-2 (ESD)	Air Discharge ±15 Contact Discharge ±8	KV
	IEC61000-4-4 (EFT)	40	A
	IEC61000-4-5 (Lightning)	24	A

Transient Voltage Suppressors Array for ESD Protection

Low Capacitance

SLVU2.8

Electrical Characteristics (@ 25°C Unless Otherwise Specified)

Part Number	Device Marking	V _{RWM} (V) (Max.)	V _B (V) (Min.)	I _T (mA)	V _C @5A (Max.)	V _C		I _R (μA) (Max.)	C (pF) (Typ.)
						(Max.)	(@A)		
SLVU2.8	328	2.8	3.0	1	7	20	24	1	3

Fig1. 8/20μs Pulse Waveform

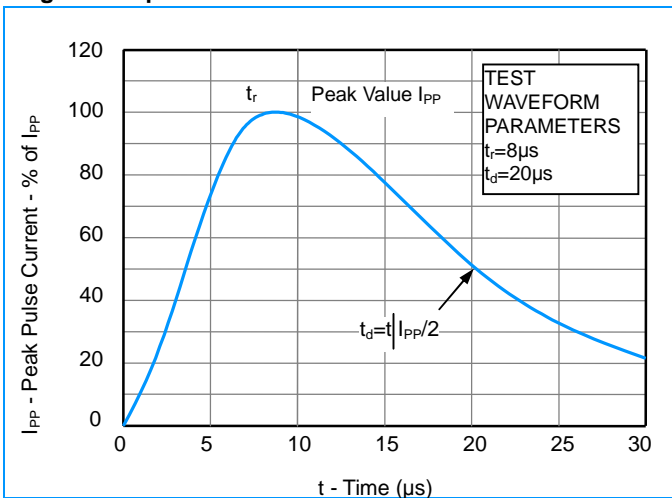

Fig2. ESD Pulse Waveform (according to IEC 61000-4-2)

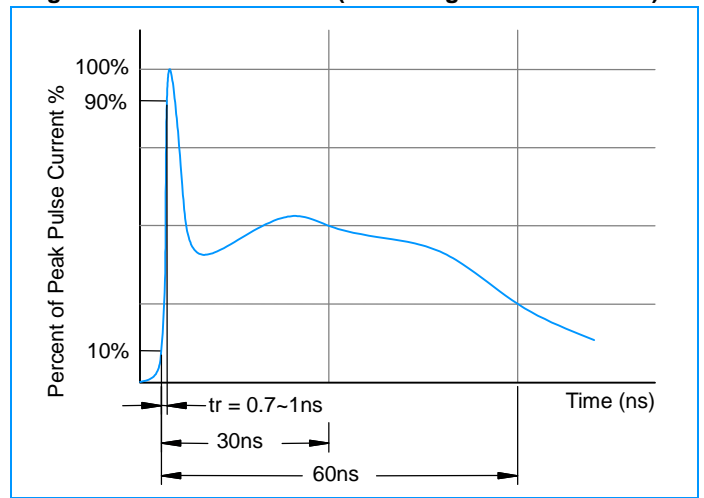
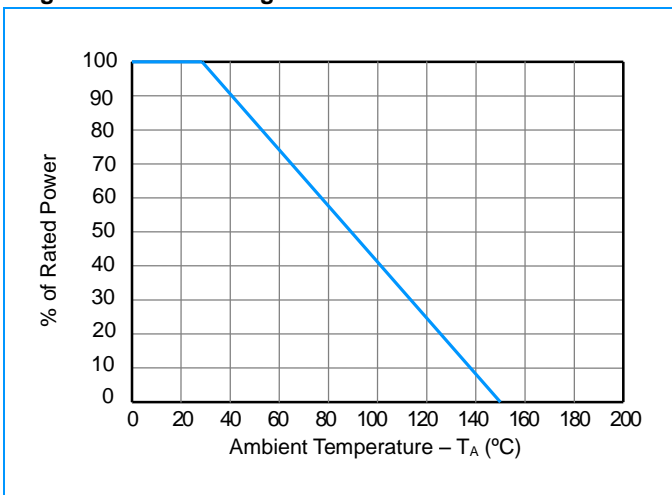

Fig3. Power Derating Curve



Transient Voltage Suppressors Array for ESD Protection

Low Capacitance

SLVU2.8

SOT-23 Package Outline & Dimensions

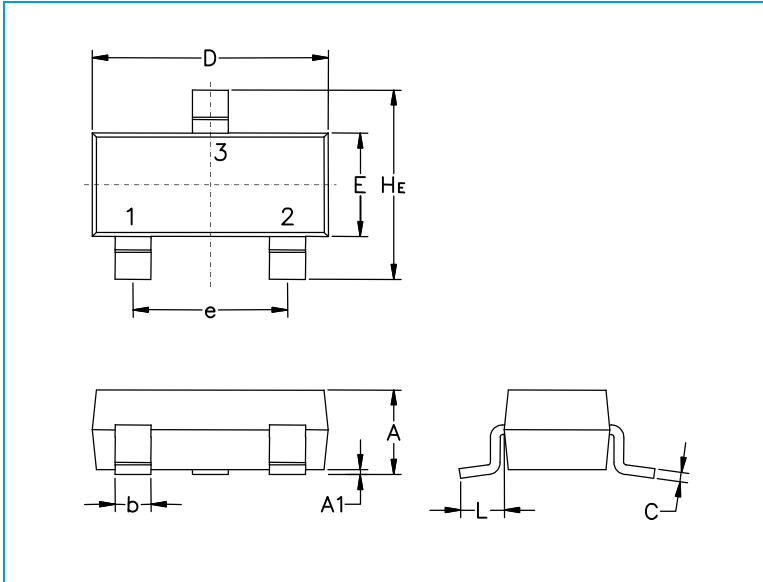

Symbol	Millimeters			Inches		
	Min.	Nom.	Max.	Min.	Nom.	Max.
A	0.89	1.00	1.11	0.035	0.040	0.044
A1	0.01	0.06	0.10	0.001	0.002	0.004
b	0.37	0.44	0.50	0.15	0.18	0.020
c	0.09	0.13	0.18	0.003	0.005	0.007
D	2.80	2.90	3.04	0.110	0.114	0.120
E	1.20	1.30	1.40	0.047	0.051	0.055
e	1.78	1.90	2.04	0.070	0.075	0.081
L	0.35	0.54	0.69	0.014	0.021	0.029
HE	2.10	2.40	2.64	0.083	0.094	0.104

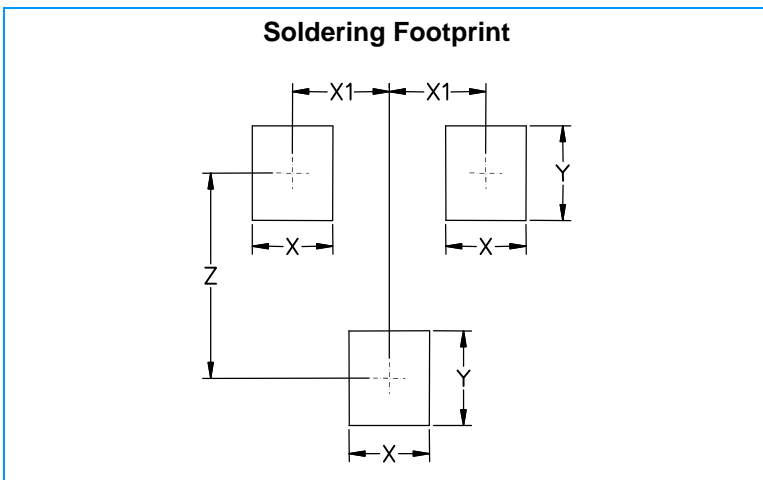

Symbol	Millimeters	Inches
X	0.80	0.031
X1	0.95	0.037
Y	0.90	0.035
Z	2.00	0.079